

4-ACHSIGER CONTAINERWAGEN  
 4-AXLE CONTAINER CARRIER

# Sgnss 60<sup>0</sup> M14

Meistbenutzter "Allround"-Wagen für den Intermodalverkehr, mit einem idealen Ladegewicht von 70 t. Sehr gut geeignet für maritime Container, Tankcontainer und Wechselbehälter.

*Most flexible "allround" railcar for intermodal transportation with an ideal loading weight of 70 t. Excellent suitable for maritime containers, tank containers and swap bodies.*

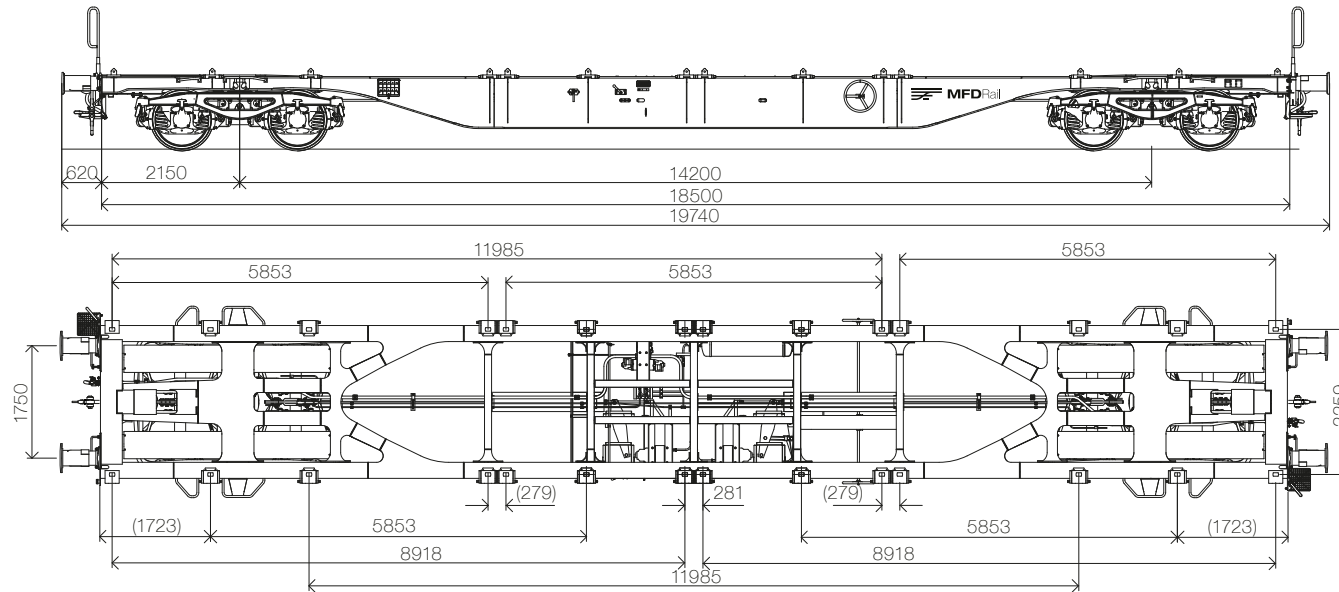

4-ACHSIGER CONTAINERWAGEN  
 4-AXLE CONTAINER CARRIER

# Sgnss 60<sup>o</sup> M14

**TECHNISCHE DATEN /Technical Data:**

Eigengewicht: /Tare Weight:	<b>ca. 20.0 t</b>	Drehgestell: /Bogie:	<b>Y25 Ls(s)d1</b>
Max. Zuladung: /Max. Load:	<b>70 t</b>	Bremssohlen (K): /Brake blocks:	<b>Jurid 816M 320</b>
Radsatzlast: /Axle Load:	<b>22.5 t</b>	Bremse: /Brake:	<b>KE-GP-A</b>
Radsatzbauart: /Wheelset type:	<b>BA 314</b>	Puffer: /Buffers:	<b>Kat. A 105 / 2750</b>
Radsatzlager: /Wheelset bearing:	<b>BA 182</b>	Handbremsgewicht: /Handbrake weight:	<b>22.8 t / 22.8 kN</b>
Schraubenkupplung: /Screw coupling:	<b>1'350 kN</b>	Fährschiff: /Ferry boats:	<b>2°30'</b>
Zugvorrichtung: /Pulling device:	<b>1'500 kN</b>		

**BETRIEBSDATEN /Operating Data:**

Länge über Puffer: /Total length over buffers:	<b>19.64 m / 19.74 m</b>	Max. Bremsgewicht: /Max. brake weight:	<b>72 t</b>
Ladelänge: /Loading length:	<b>18.50 m</b>	Bremseinstellung: /Brake adjustment:	<b>SS</b>
Drehzapfenabstand: /Pivot spacing:	<b>14.20 m</b>	Geschwindigkeit max.: /Max. speed:	<b>120 km/h</b>
Ladehöhe ab S.O.: /Loading height from top of rail:	<b>1'155 mm</b>	Containerzapfen: /Containerpins:	<b>28</b>
Kurvenradius: /Curve-radius: Einzelwagen /Single wagon 75 m Zugsverband /Train set 150m		Einsatzbereich: /Range of use:	<b>TEN / GE</b>
		Lichtraumprofil: /Clearance profile:	<b>G1</b>
		Klimazone: /Climate zone:	<b>T1</b>

**LASTGRENZRASTER /Load limits:**

	A	B	C	D	
<b>S</b>	44.0	52.0	62.0	70.0	★★★★
<b>SS</b>	44.0	53.0	60.0		



4-ACHSIGER CONTAINERWAGEN  
4-AXLE CONTAINER CARRIER

# Sgnss 60<sup>o</sup> M14

**BELADESCHEMA**  
**/Loading scheme M14:**

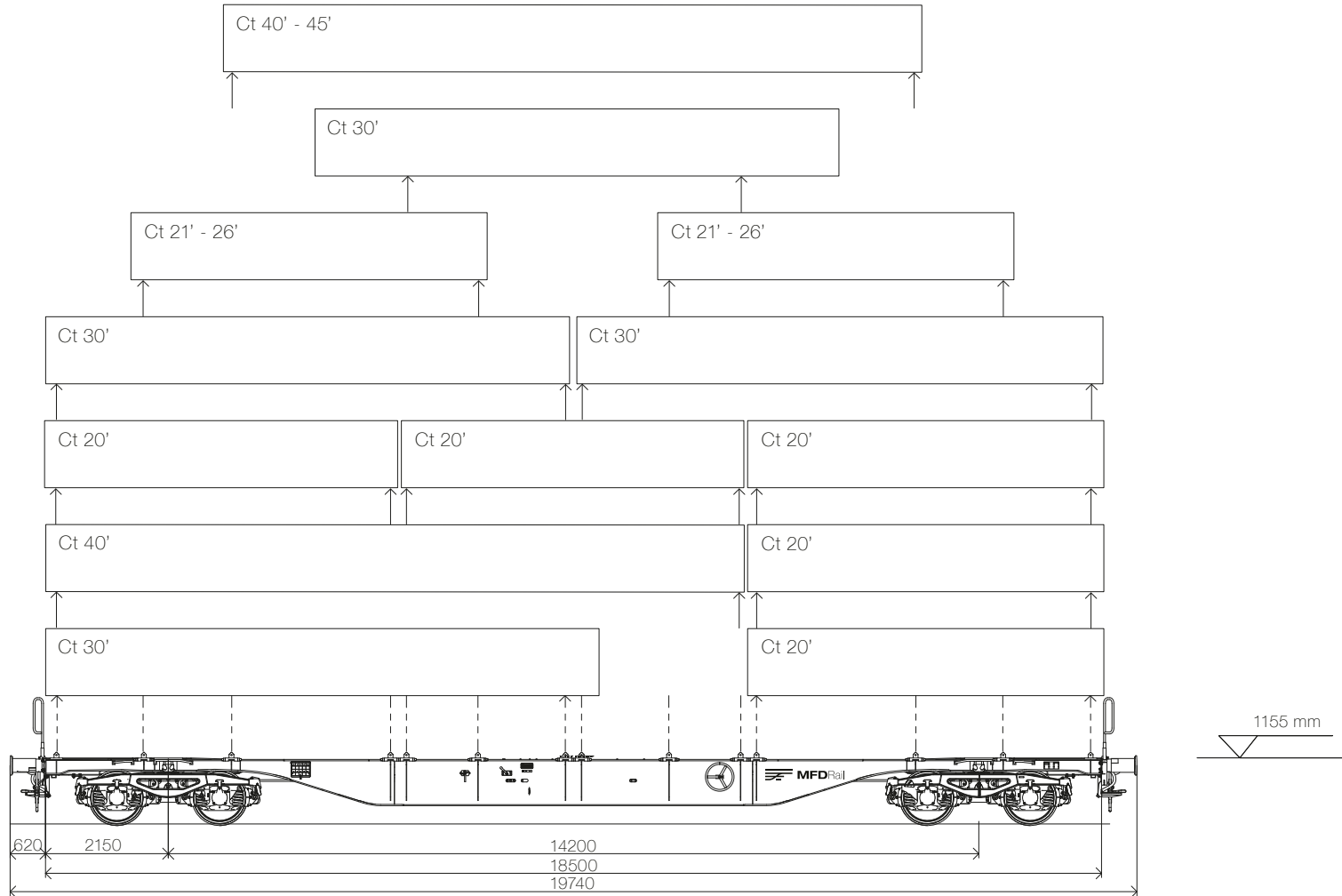

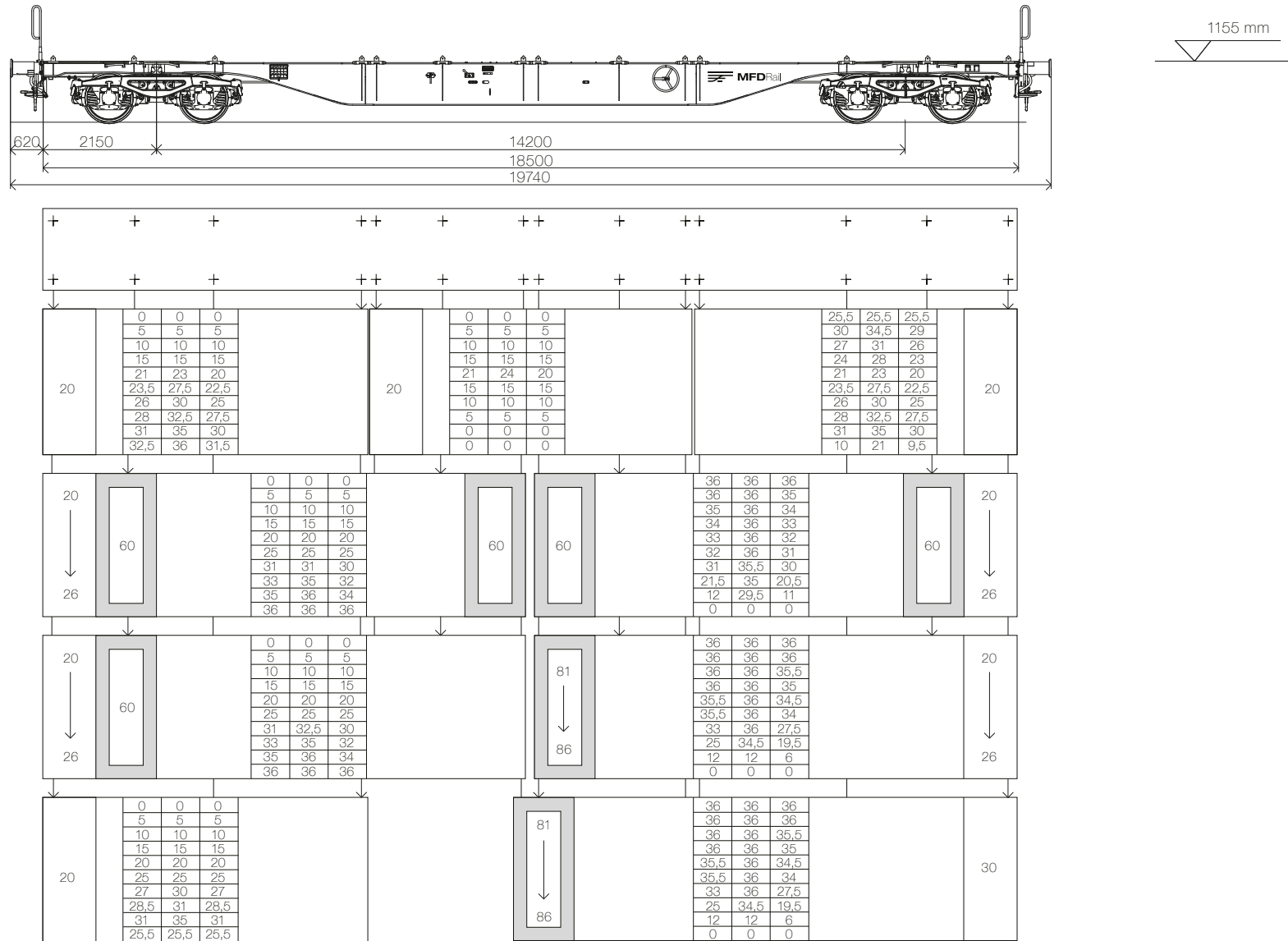
**BELADESCHEMA  
 /Loading scheme M14:**

**BELADESCHEMA**  
/Loading scheme M14:

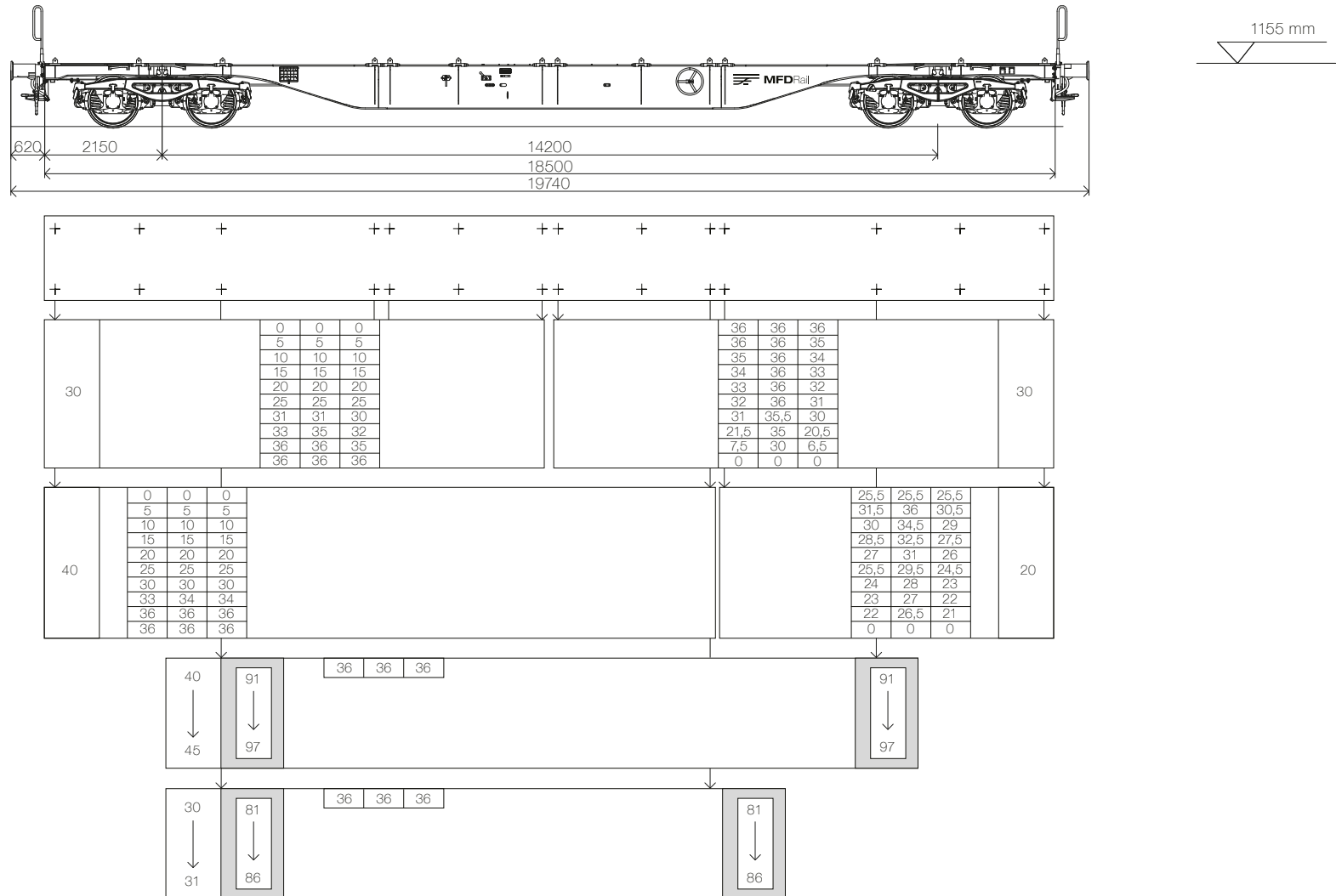

**ERKLÄRUNGEN FÜR BELADESCHEMAS /Explanations for loading scheme:**

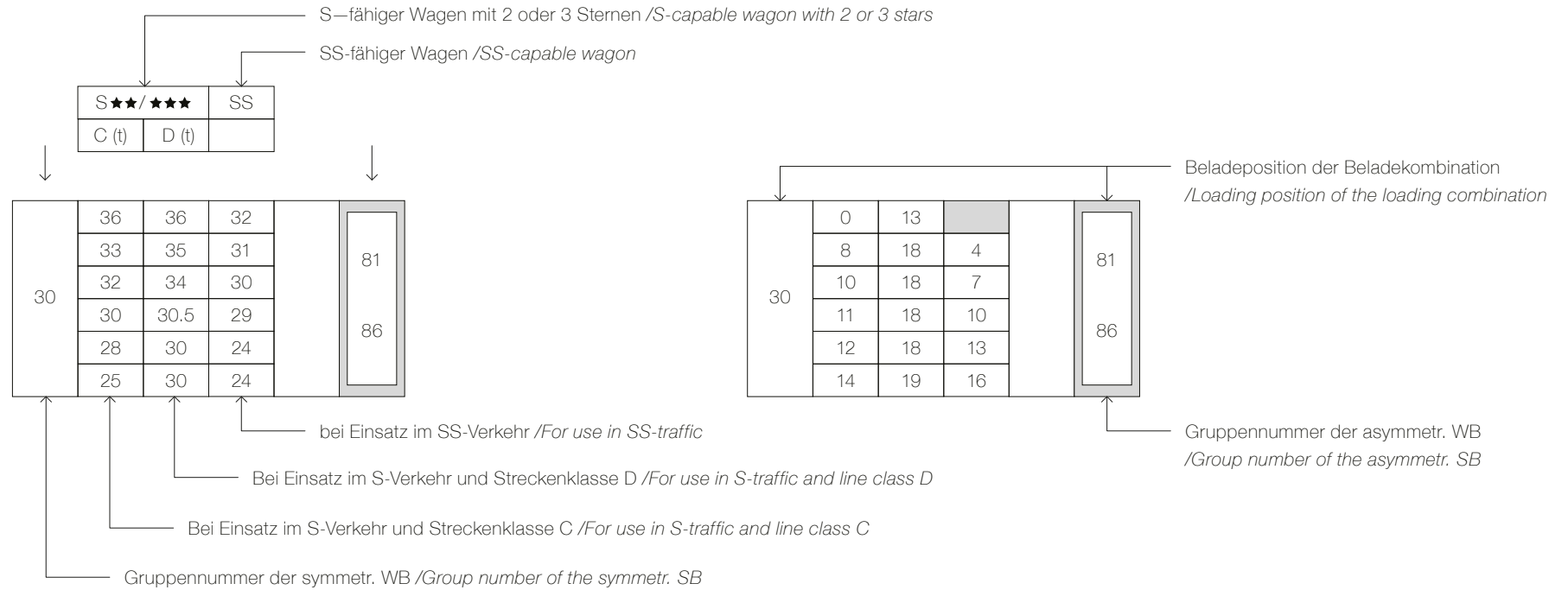

- ★ Fester Containerzapfen /Fixed container pin
- + Seitlich nicht verschiebbarer, klappbarer Containerzapfen /foldable container spigots that cannot be moved sideways
- 0 Leerer Wagenstellplatz /empty wagon storage area

- Klappbare Wechselbehälterunterstützung (aussen) /outside foldable swap body support
- S Vmax. 100 km/h ohne besondere betriebliche Bedingungen /Vmax. 100 km/h without special operational conditions
- SS Vmax. 120 km/h ohne besondere betriebliche Bedingungen /Vmax. 120 km/h without special operational conditions

**WECHSELCONTAINER ZUGEHÖRIGKEIT DER GRUPPE M14 /Exchange container affiliation of the group M14:**

**A. Symmetrische Abmessungen**  
*A. Symmetrical dimensions*

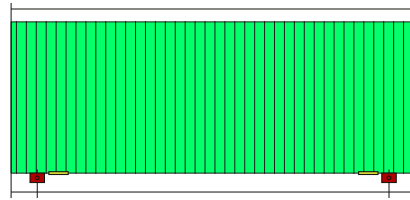

Gruppen Nr. <i>Group nr.</i>	Max. Länge (mm) <i>Max. length (mm)</i>	Max. Überhang (mm) <i>Max. overhang (mm)</i>	Befestigungsbeschlag Mindestabstand (mm) <i>Mounting bracket minimum distance (mm)</i>	Maximaler Überhang (mm) <i>Max. overhang (mm)</i>
20	6058	102.5	5853 +/- 3	102.5
21	6250	198.5	5853 +/- 3	198.5
22	7150	648.5	5853 +/- 3	648.5
23	7450	798.5	5853 +/- 3	798.5
24	7820	983.5	5853 +/- 3	983.5
26	8150	1148.5	5853 +/- 3	1148.5
30	9125	103.5	8918 +/- 4	103.5
31	9300	191.0	8918 +/- 4	191.0
40	12192	103.5	11985 +/- 5	103.5
42	12500	257.5	11985 +/- 5	257.5
44	13100	557.5	11985 +/- 5	557.5
45	13716	865.5	11985 +/- 5	865.5

**B. Asymmetrische Abmessungen**  
*B. Asymmetrical dimensions*

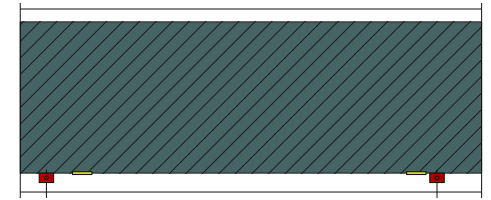

Gruppen Nr. <i>Group nr.</i>	Max. Länge (mm) <i>Max. length (mm)</i>	Max. Überhang (mm) <i>Max. overhang (mm)</i>	Befestigungsbeschlag Mindestabstand (mm) <i>Mounting bracket minimum distance (mm)</i>	Maximaler Überhang (mm) <i>Max. overhang (mm)</i>
60	8543	1190.0	5853 +/- 3	1500.0
81	9275	103.5	8918 +/- 4	253.5
82	9330	103.5	8918 +/- 4	308.5
84	10040	103.5	8918 +/- 4	1018.5
85	10200	103.5	8918 +/- 4	1178.5
86	10900	103.5	8918 +/- 4	1878.5
91	12500	103.5	11985 +/- 5	411.5
94	12750	103.5	11985 +/- 5	661.5
95	13200	257.5	11985 +/- 5	957.5
96	13600	715.0	11985 +/- 5	900.0
97	14040	715.0	11985 +/- 5	1340.0