

4-ACHSIGER CONTAINERWAGEN
4-AXLE CONTAINER CARRIER

Sgmmnss 40' M18

Mit seinem Ladegewicht von 73 t ist der Sgmmnss der ideale Wagen für den Transport extrem schwerer 20', 30' oder 40' Container bzw. Tankcontainern.

With its loading weight of 73 t is this Sgmmnss the ideal railcar for the transport of extremely heavy 20', 30' or 40' containers or tank containers.

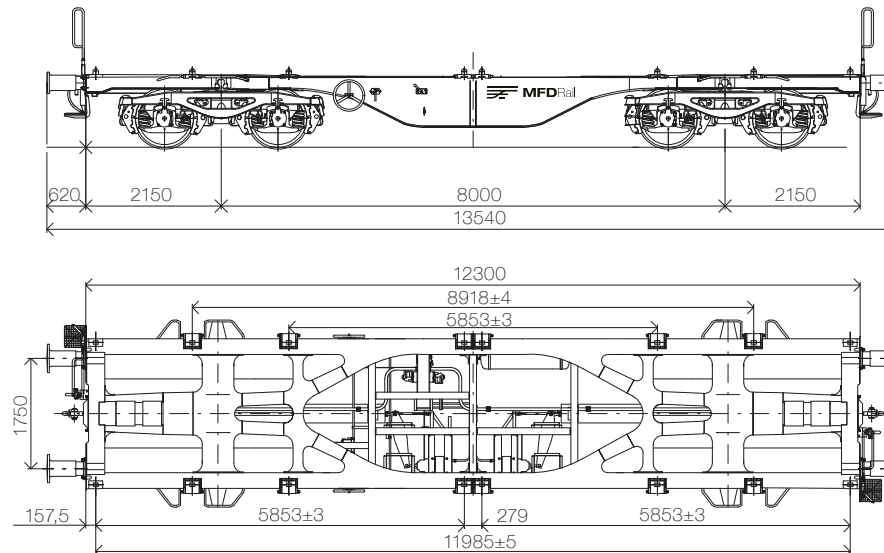

4-ACHSIGER CONTAINERWAGEN
4-AXLE CONTAINER CARRIER

Sgmmnss 40⁺ M18

TECHNISCHE DATEN /Technical Data:

Eigengewicht: /Tare Weight:	16.5 t	Zugvorrichtung: /Pulling device:	1'500 kN
Max. Zuladung: /Max. Load:	73.5 t	Drehgestell: /Bogie:	Y25 Ls1-K
Radsatzlast: /Axle Load:	22.5 t	Bremssohlen (K): /Brake blocks:	Jurid 816M 320
Radsatzbauart: /Wheelset type:	BA 314	Bremse: /Brake:	KE-GP-A
Radsatzlager: /Wheelset bearing:	BA 386	Puffer: /Buffers:	Kat. A 105
Schraubenkupplung: /Screw coupling:	1'350 kN	Handbremsgewicht: /Handbrake weight:	22.5 t / 22.5 kN

BETRIEBSDATEN /Operating Data:

Länge über Puffer: /Total length over buffers:	13.63 m	Bremseinstellung: /Brake adjustment:	SS
Ladelänge: /Loading length:	12.39 m	Geschwindigkeit max.: /Max. speed:	120 km/h
Drehzapfenabstand: /Pivot spacing:	8.67 m	Containerzapfen: /Containerpins:	16
Ladehöhe ab S.O.: /Loading height from top of rail:	1'095 mm	Einsatzbereich: /Range of use:	TEN / GE
Kurvenradius: /Curve-radius:	35 m	Lichtraumprofil: /Clearance profile:	G1
Max. Bremsgewicht: /Max. brake weight:	72 t	Klimazone: /Climate zone:	T1

LASTGRENZRASTER /Load limits:

	A	B	C	D	
S	47.5	55.5	65.5	73.5	★★★★
SS	47.5	55.5	63.5		

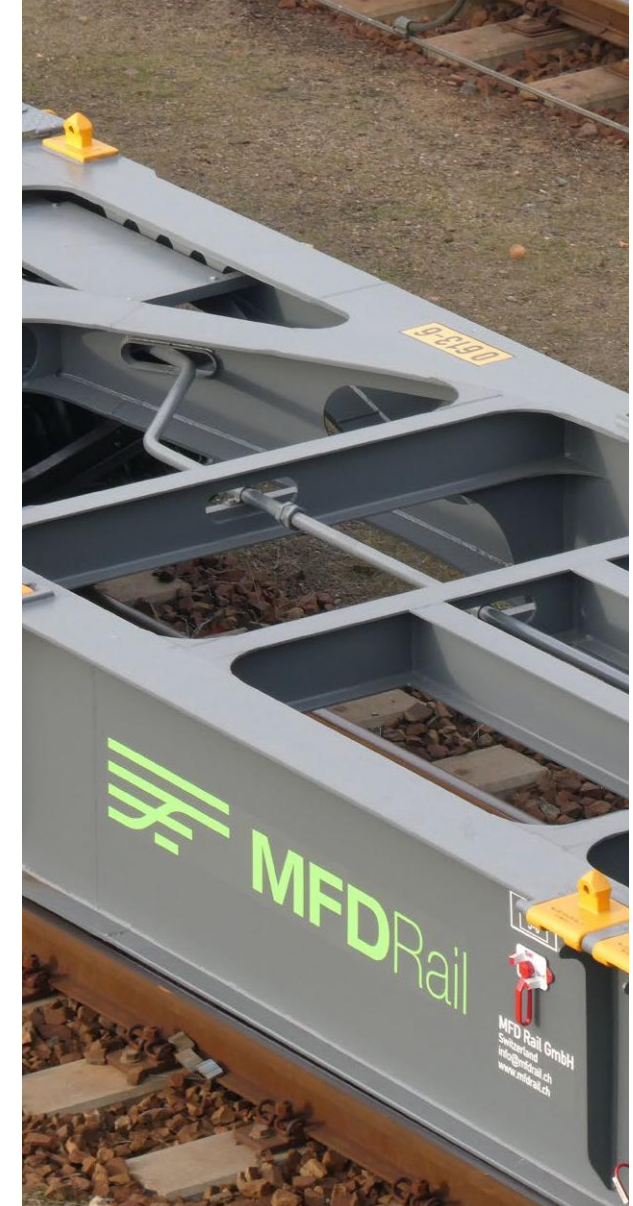

4-ACHSIGER CONTAINERWAGEN
4-AXLE CONTAINER CARRIER

Sgmmnss 40^o M18

BELADESCHEMA
/Loading scheme M18:

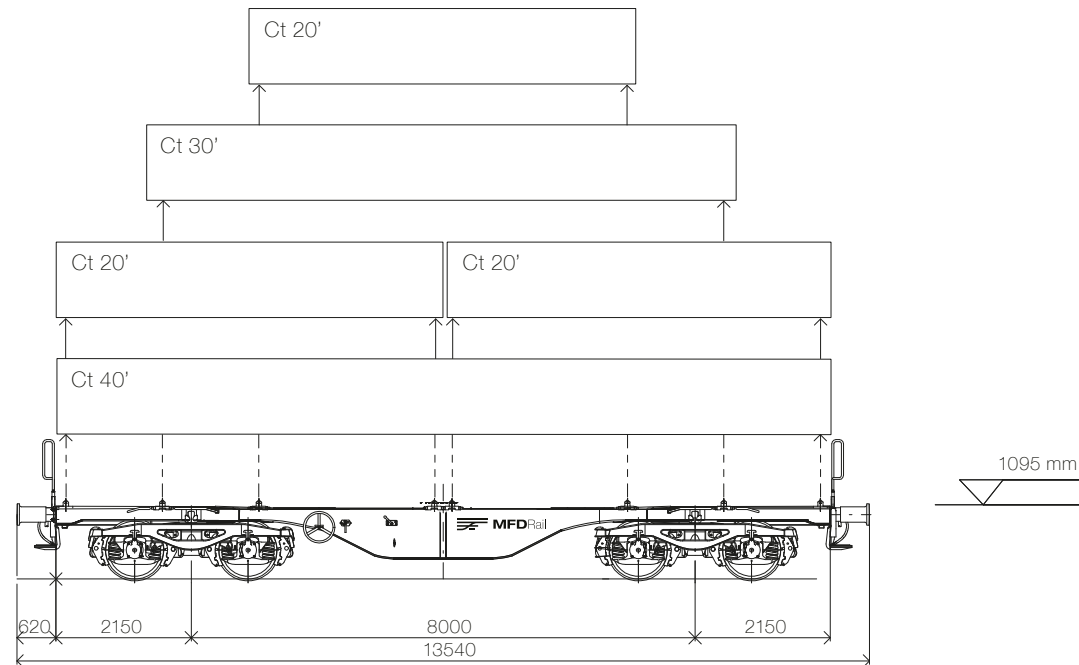

BELADESCHEMA
/Loading scheme M18:

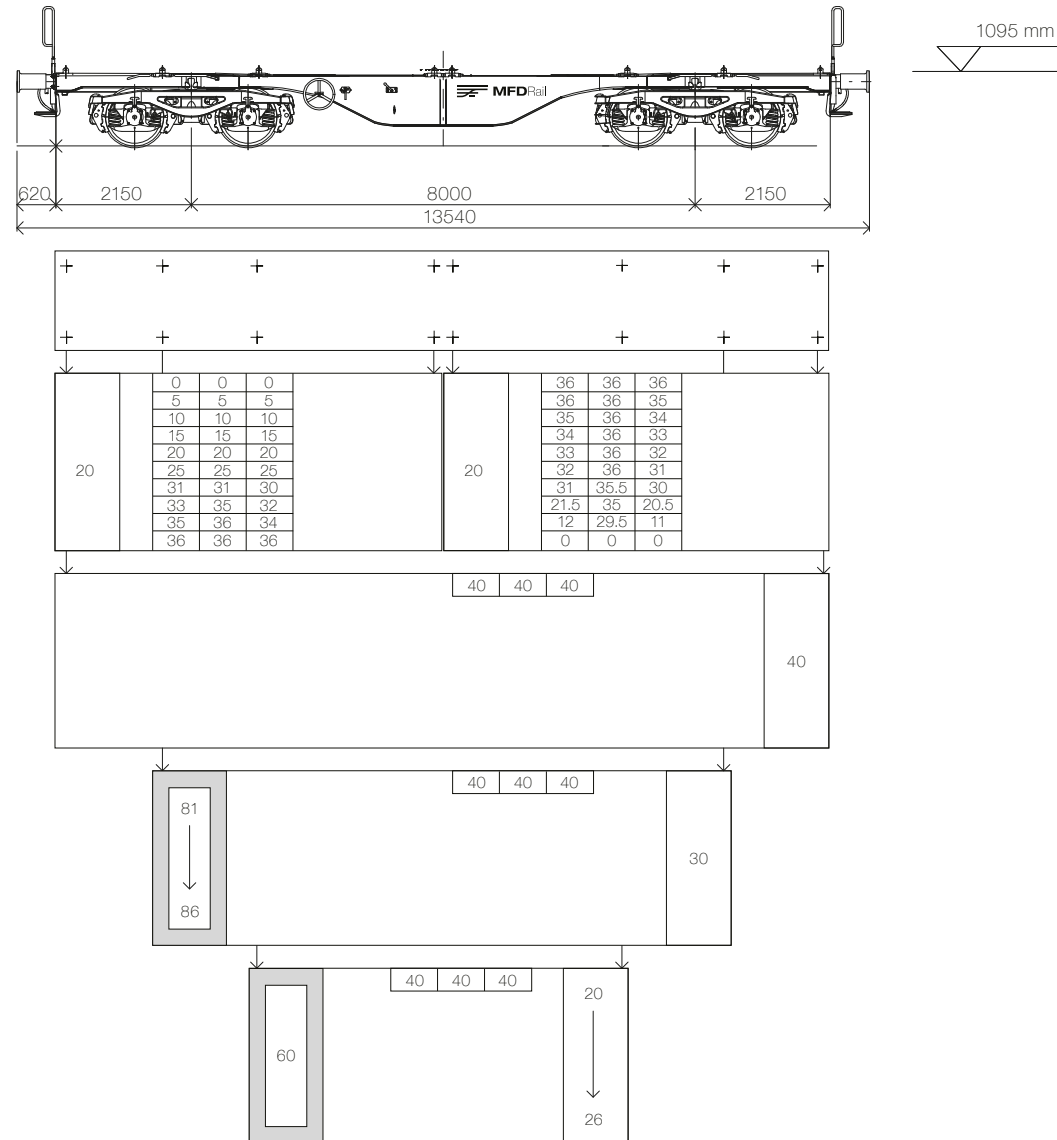

ERKLÄRUNGEN FÜR BELADESCHEMAS /Explanations for loading scheme:

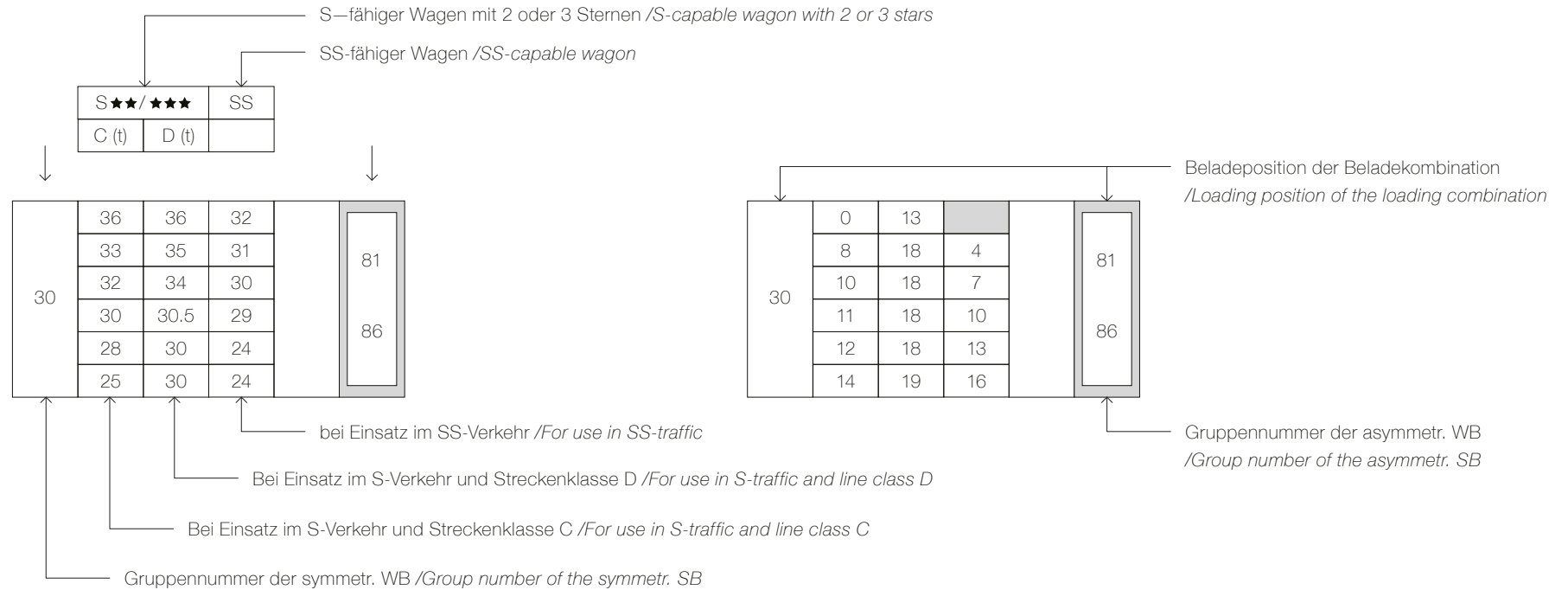

- ★ Fester Containerzapfen /Fixed container pin
 - + Seitlich nicht verschiebbarer, klappbarer Containerzapfen /foldable container spigots that cannot be moved sideways
- 0 Leerer Wagenstellplatz /empty wagon storage area

- Klappbare Wechselbehälterunterstützung (aussen) /outside foldable swap body support
- S Vmax. 100 km/h ohne besondere betriebliche Bedingungen /Vmax. 100 km/h without special operational conditions
- SS Vmax. 120 km/h ohne besondere betriebliche Bedingungen /Vmax. 120 km/h without special operational conditions

WECHSELCONTAINER ZUGEHÖRIGKEIT DER GRUPPE M18 /Exchange container affiliation of the group M18:

A. Symmetrische Abmessungen
A. Symmetrical dimensions

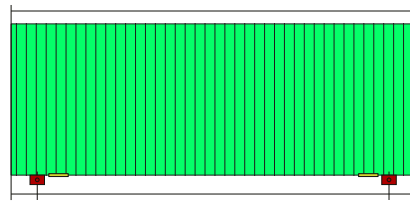

Gruppen Nr. <i>Group nr.</i>	Max. Länge (mm) <i>Max. length (mm)</i>	Max. Überhang (mm) <i>Max. overhang (mm)</i>	Befestigungsbeschlag Mindestabstand (mm) <i>Mounting bracket minimum distance (mm)</i>	Maximaler Überhang (mm) <i>Max. overhang (mm)</i>
20	6058	102.5	5853 +/- 3	102.5
21	6250	198.5	5853 +/- 3	198.5
22	7150	648.5	5853 +/- 3	648.5
23	7450	798.5	5853 +/- 3	798.5
24	7820	983.5	5853 +/- 3	983.5
26	8150	1148.5	5853 +/- 3	1148.5
30	9125	103.5	8918 +/- 4	103.5
31	9300	191.0	8918 +/- 4	191.0
40	12192	103.5	11985 +/- 5	103.5

B. Asymmetrische Abmessungen
B. Asymmetrical dimensions

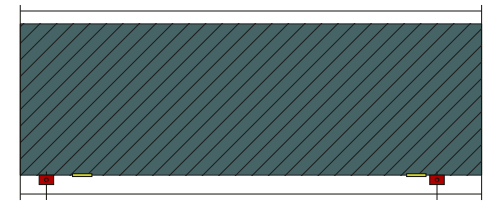

Gruppen Nr. <i>Group nr.</i>	Max. Länge (mm) <i>Max. length (mm)</i>	Max. Überhang (mm) <i>Max. overhang (mm)</i>	Befestigungsbeschlag Mindestabstand (mm) <i>Mounting bracket minimum distance (mm)</i>	Maximaler Überhang (mm) <i>Max. overhang (mm)</i>
60	8543	1190.0	5853 +/- 3	1500.0
81	9275	103.5	8918 +/- 4	253.5
82	9330	103.5	8918 +/- 4	308.5
84	10040	103.5	8918 +/- 4	1018.5
85	10200	103.5	8918 +/- 4	1178.5
86	10900	103.5	8918 +/- 4	1878.5