

4-ACHSIGER CONTAINERWAGEN
4-AXLE CONTAINER CARRIER

Sgnss 60^o M14

Meistbenutzter "Allround"-Wagen für den Intermodalverkehr, mit einem idealen Ladegewicht von 70 t. Sehr gut geeignet für maritime Container, Tankcontainer und Wechselbehälter.

Most flexible "allround" railcar for intermodal transportation with an ideal loading weight of 70 t. Excellent suitable for maritime containers, tank containers and swap bodies.

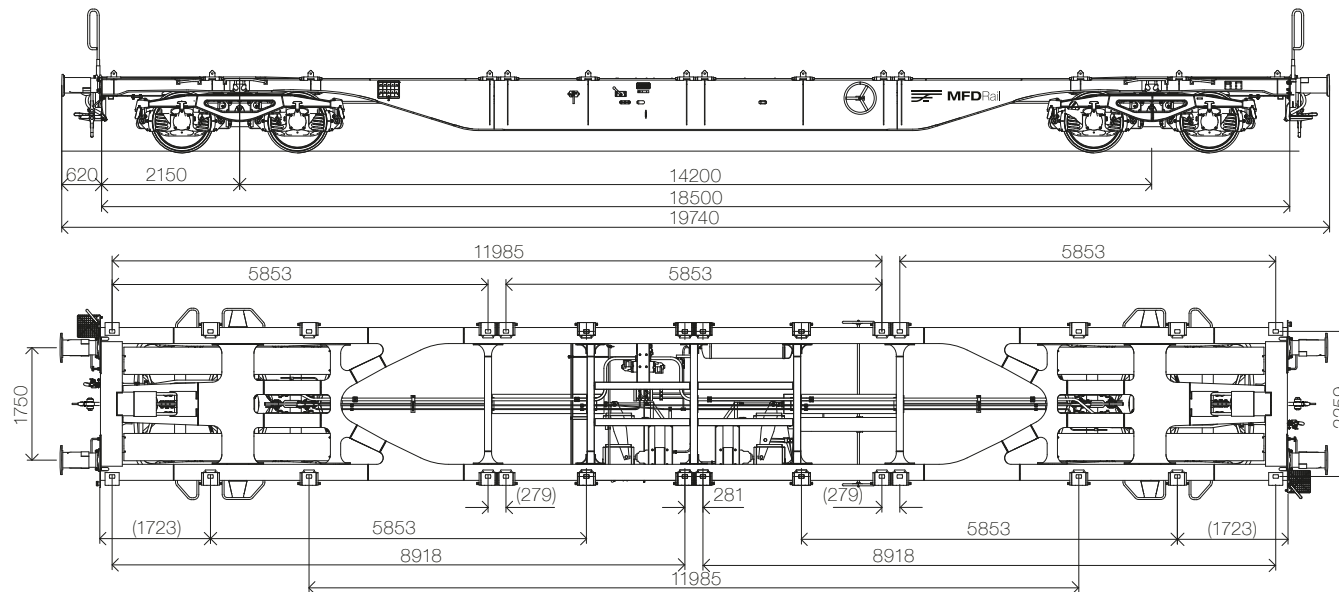

4-ACHSIGER CONTAINERWAGEN
4-AXLE CONTAINER CARRIER

Sgnss 60^o M14

TECHNISCHE DATEN /Technical Data:

Eigengewicht: /Tare Weight:	ca. 20.0 t	Drehgestell: /Bogie:	Y25 Ls(s)d1
Max. Zuladung: /Max. Load:	70 t	Bremssohlen (K): /Brake blocks:	Jurid 816M 320
Radsatzlast: /Axle Load:	22.5 t	Bremse: /Brake:	KE-GP-A
Radsatzbauart: /Wheelset type:	BA 314	Puffer: /Buffers:	Kat. A 105 / 2750
Radsatzlager: /Wheelset bearing:	BA 182	Handbremsgewicht: /Handbrake weight:	22.8 t / 22.8 kN
Schraubenkupplung: /Screw coupling:	1'350 kN	Fährschiff: /Ferry boats:	2°30'
Zugvorrichtung: /Pulling device:	1'500 kN		

BETRIEBSDATEN /Operating Data:

Länge über Puffer: /Total length over buffers:	19.64 m / 19.74 m	Max. Bremsgewicht: /Max. brake weight:	72 t
Ladelänge: /Loading length:	18.50 m	Bremseinstellung: /Brake adjustment:	SS
Drehzapfenabstand: /Pivot spacing:	14.20 m	Geschwindigkeit max.: /Max. speed:	120 km/h
Ladehöhe ab S.O.: /Loading height from top of rail:	1'155 mm	Containerzapfen: /Containerpins:	28
Kurvenradius: /Curve-radius:	Einzelwagen /Single railcar 75 m Zugsverband /Train set 150m	Einsatzbereich: /Range of use:	TEN / GE
		Lichtraumprofil: /Clearance profile:	G1
		Klimazone: /Climate zone:	T1

LASTGRENZRASTER /Load limits:

	A	B	C	D	
S	44.0	52.0	62.0	70.0	★★★
SS	44.0	53.0	61.0		

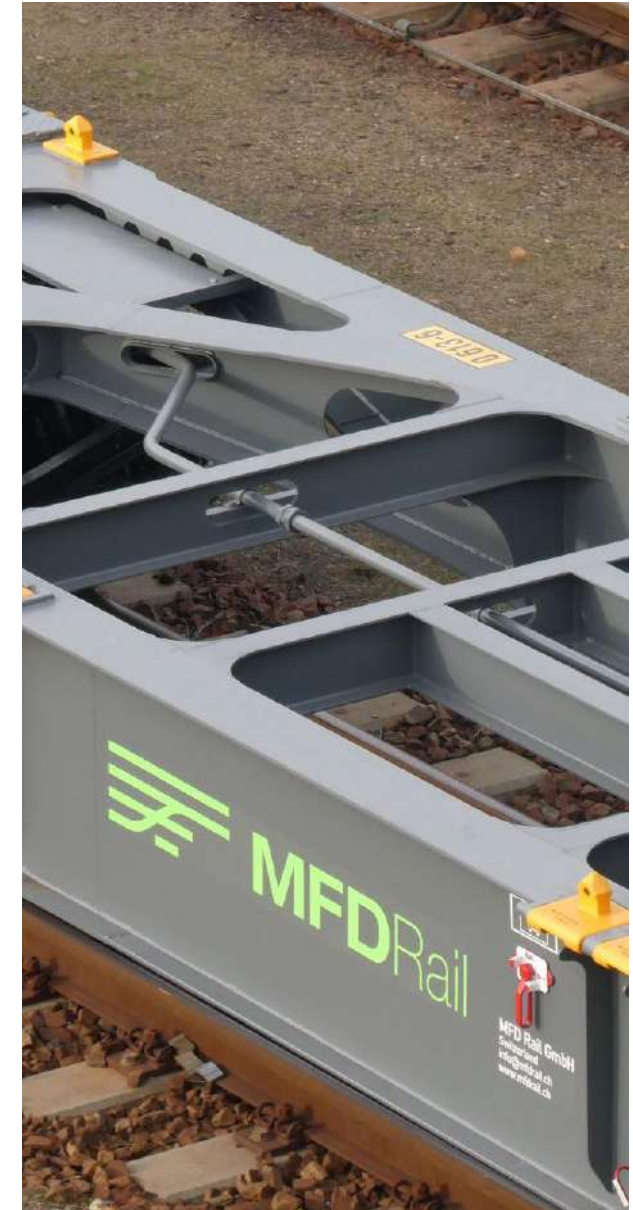

4-ACHSIGER CONTAINERWAGEN
4-AXLE CONTAINER CARRIER

Sgnss 60^o M14

BELADESCHEMA
/Loading scheme M14:

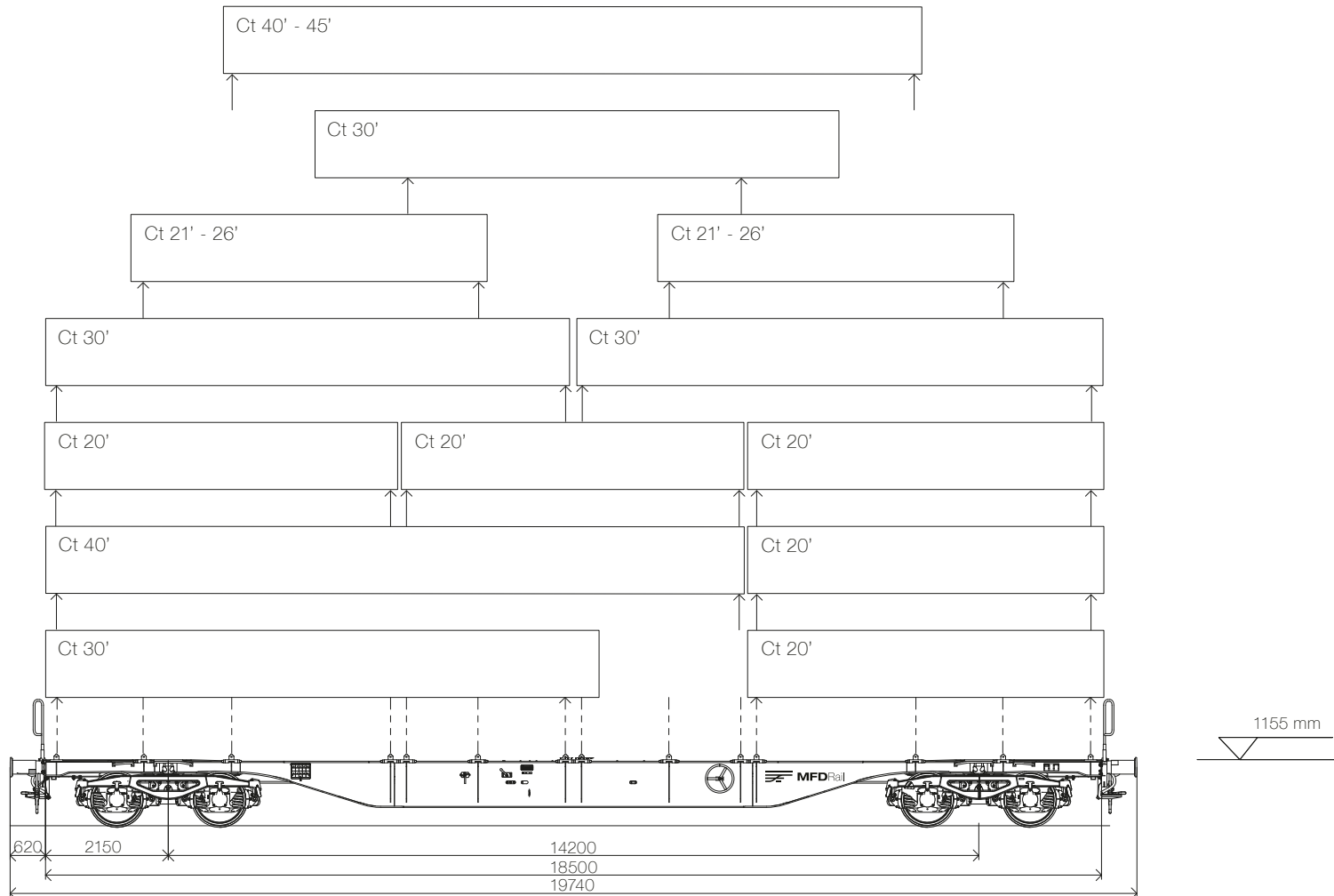

BELADESCHEMA
/Loading scheme M14:

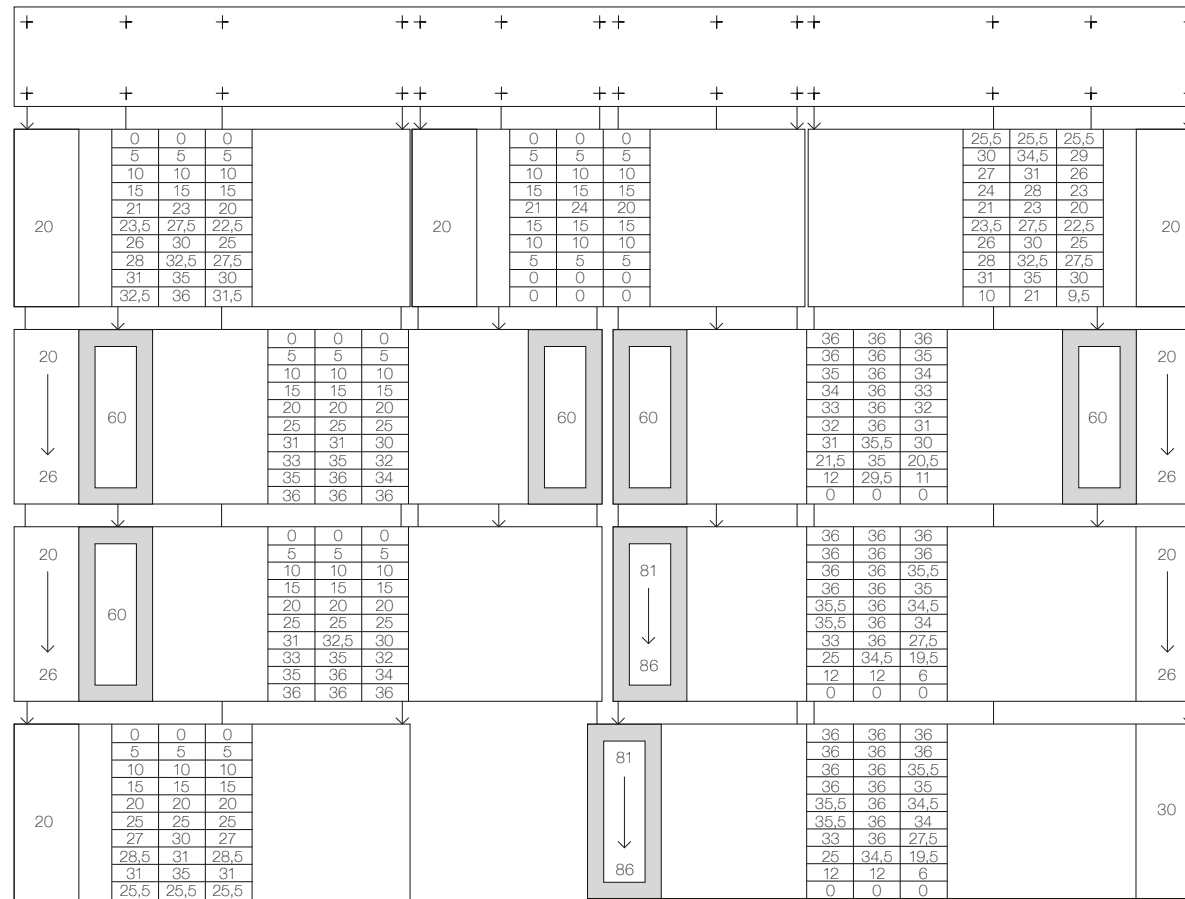
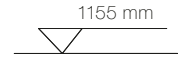
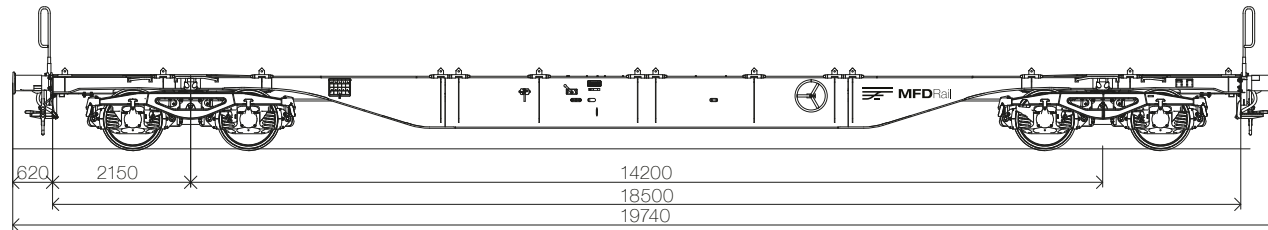

BELADESCHEMA
/Loading scheme M14:

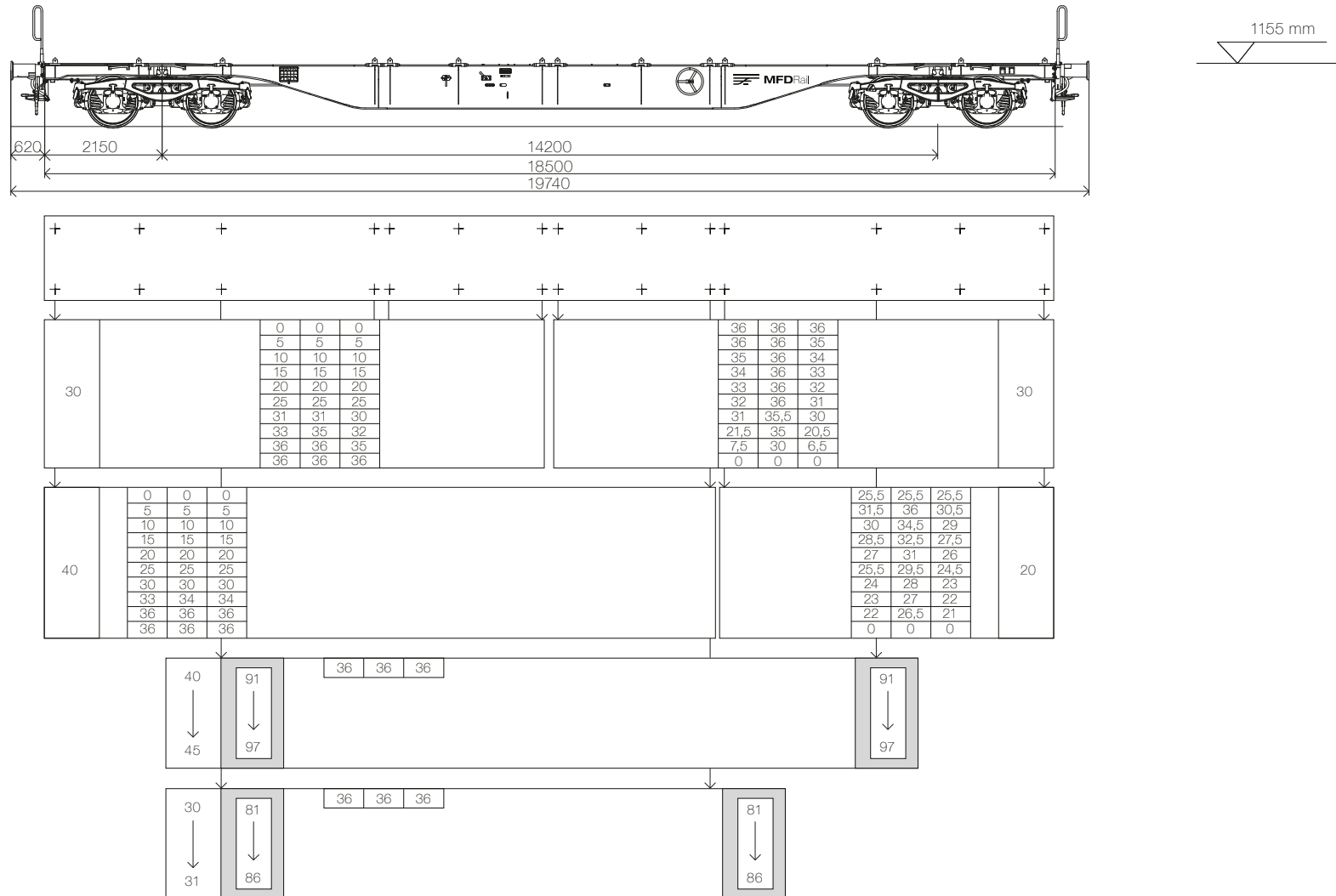

ERKLÄRUNGEN FÜR BELADESCHEMAS /Explanations for loading scheme:

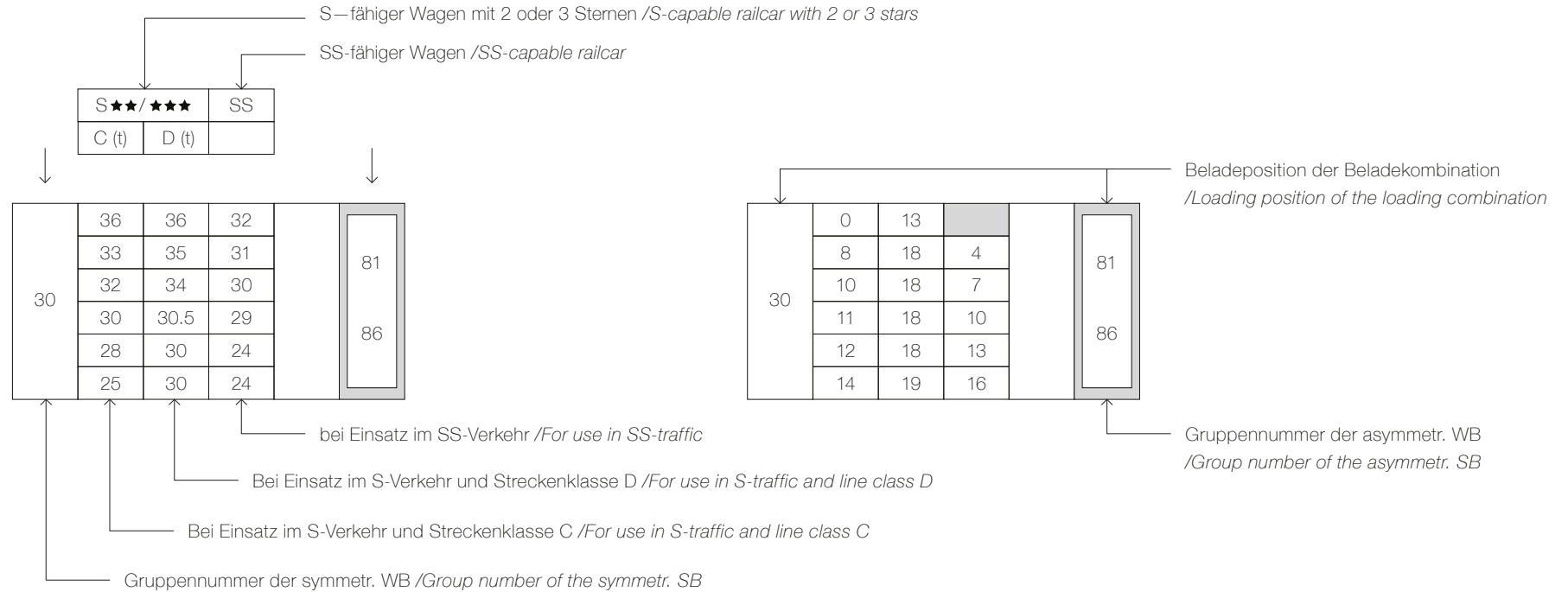

- ★ Fester Containerzapfen /Fixed container pin
- + Seitlich nicht verschiebbarer, klappbarer Containerzapfen /foldable container spigots that cannot be moved sideways
- 0 Leerer Wagenstellplatz /empty railcar storage area

- Klappbare Wechselbehälterunterstützung (aussen) /outside foldable swap body support
- S Vmax. 100 km/h ohne besondere betriebliche Bedingungen /Vmax. 100 km/h without special operational conditions
- SS Vmax. 120 km/h ohne besondere betriebliche Bedingungen /Vmax. 120 km/h without special operational conditions

WECHSELCONTAINER ZUGEHÖRIGKEIT DER GRUPPE M14 /Exchange container affiliation of the group M14:

A. Symmetrische Abmessungen
A. Symmetrical dimensions

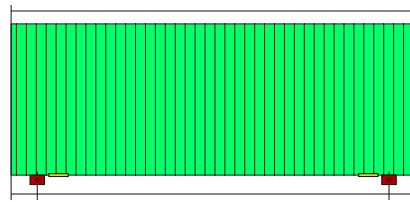

Gruppen Nr. <i>Group nr.</i>	Max. Länge (mm) <i>Max. length (mm)</i>	Max. Überhang (mm) <i>Max. overhang (mm)</i>	Befestigungsbeschlag Mindestabstand (mm) <i>Mounting bracket minimum distance (mm)</i>	Maximaler Überhang (mm) <i>Max. overhang (mm)</i>
20	6058	102.5	5853 +/- 3	102.5
21	6250	198.5	5853 +/- 3	198.5
22	7150	648.5	5853 +/- 3	648.5
23	7450	798.5	5853 +/- 3	798.5
24	7820	983.5	5853 +/- 3	983.5
26	8150	1148.5	5853 +/- 3	1148.5
30	9125	103.5	8918 +/- 4	103.5
31	9300	191.0	8918 +/- 4	191.0
40	12192	103.5	11985 +/- 5	103.5
42	12500	257.5	11985 +/- 5	257.5
44	13100	557.5	11985 +/- 5	557.5
45	13716	865.5	11985 +/- 5	865.5

B. Asymmetrische Abmessungen
B. Asymmetrical dimensions

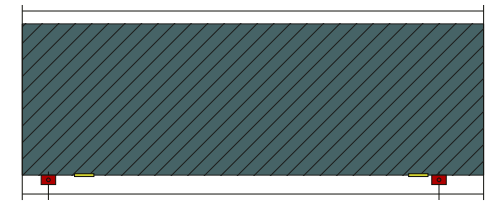

Gruppen Nr. <i>Group nr.</i>	Max. Länge (mm) <i>Max. length (mm)</i>	Max. Überhang (mm) <i>Max. overhang (mm)</i>	Befestigungsbeschlag Mindestabstand (mm) <i>Mounting bracket minimum distance (mm)</i>	Maximaler Überhang (mm) <i>Max. overhang (mm)</i>
60	8543	1190.0	5853 +/- 3	1500.0
81	9275	103.5	8918 +/- 4	253.5
82	9330	103.5	8918 +/- 4	308.5
84	10040	103.5	8918 +/- 4	1018.5
85	10200	103.5	8918 +/- 4	1178.5
86	10900	103.5	8918 +/- 4	1878.5
91	12500	103.5	11985 +/- 5	411.5
94	12750	103.5	11985 +/- 5	661.5
95	13200	257.5	11985 +/- 5	957.5
96	13600	715.0	11985 +/- 5	900.0
97	14040	715.0	11985 +/- 5	1340.0